

**HORLITE**<sup>®</sup>  
... Lighting

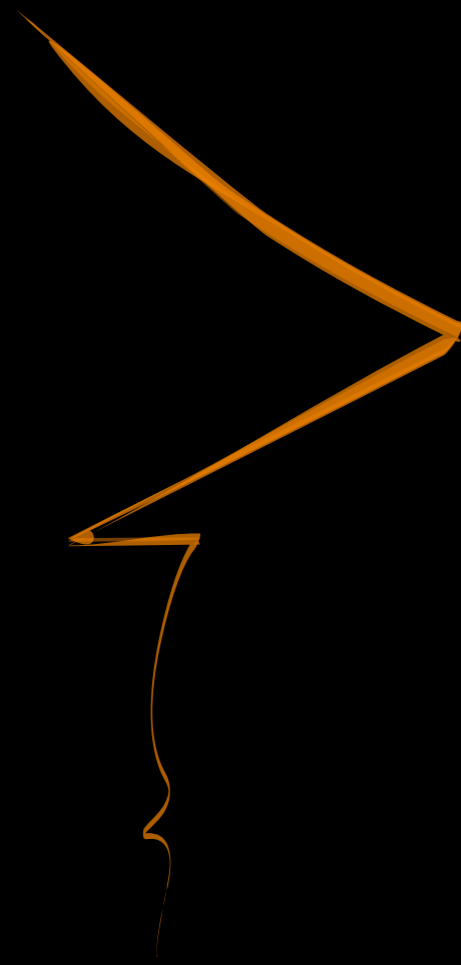

宁波鸿睿照明科技有限公司

NINGBO HONGRUI LIGHTING TECHNOLOGY CO., LTD.

Add: No. 328 Changyuan Road, Yuyao City, Ningbo, Zhejiang, China

Mr. He (G.M) 0086-15924368758

E-mail: [austinhe@horlite.com](mailto:austinhe@horlite.com) | [sales@horlite.com](mailto:sales@horlite.com)

Website: [www.horlite.com](http://www.horlite.com)

**HORLITE**<sup>®</sup>  
... Lighting



2023

Outdoor Lighting  
Plastic Material



Ningbo Hongrui Lighting Technology Co., Ltd., founded in 2014, located in Yuyao, Ningbo, is professional engaged in outdoor lights, LED indoor & outdoor lamps, LED garden lights & lawn lights, LED wall lamps, lamp connectors, lamp holders, etc ...

which are widely used in commercial lighting at home & abroad. Also our company system & our products have already passed UL, CE, RoHS, 7P certification, (as well as ETL, cUL now on process by the year 2017~2018) due to we have perfect software and hardware supports below:

1. Our hardware support: advanced precision mold processing capacity, production equipments, testing equipments etc.

2. Our software support: our high quality innovative professional technical team & sales management team.

We have already adopted advanced ERP data control system for all our production process, forming the core competitiveness of "Quality first, attention to talent & efficient service".



## ABOUT US



## Compliant the latest standards



Wall Lamp



02/page



04/page



06/page



06/page



20/page



20/page



22/page



22/page



08/page



08/page



10/page



12/page



22/page



22/page

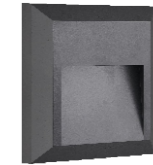

24/page



24/page



12/page



12/page



12/page



14/page

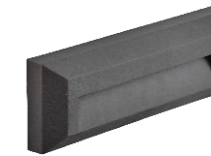

24/page



24/page



26/page



26/page



14/page



14/page



14/page



16/page



26/page



16/page



16/page



16/page



18/page

Garden Light



08/page



10/page



18/page



18/page



18/page



20/page

color available



Black



Dark Grey



White



Grey



wood



**Technology Data**

- ⊗ LED Lamp
- ⊗ Body in ABS+PC.
- ⊗ Diffuser in Opaline PP.

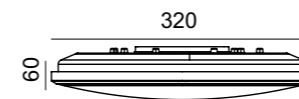

Item.No.	Watts	Lumens	Kelvin	CRI	Input	Safety type
HR10003	24W	970lm	3000K	80	220-240V~50Hz	IP54 CLASS II



**Technology Data**

- ⊗ LED Lamp
- ⊗ Body in ABS+PC.
- ⊗ Diffuser in Opaline PC.

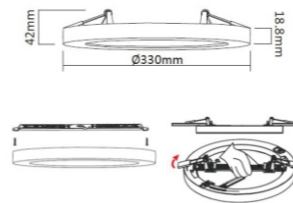
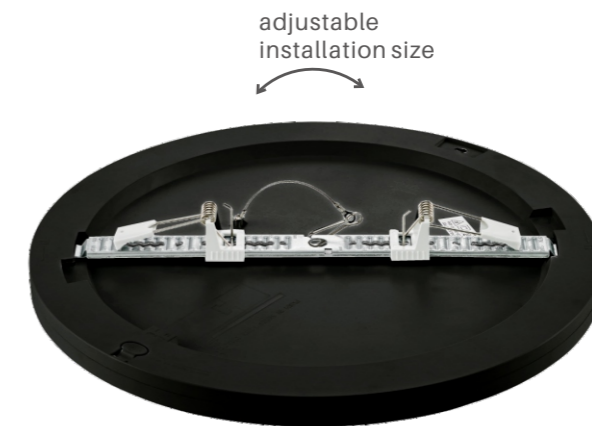

Item.No.	Watts	Lumens	Kelvin	CRI	Input	Safety type
HR10101	24W	1800lm	3000K	80	220-240V~50Hz	IP20 CLASS II



**Technology Data**

- ⊗ GU10 bulbs Max.7W
- ⊗ Body in ABS+PC.
- ⊗ Diffuser in Clear glass.



HR65051



HR65052

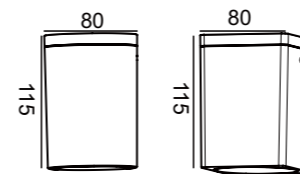

Item.No.	Watts	Light Source	Input	Safety type
HR65051	Max.7W	Gu10 bulbs	220-240V~50Hz	IP65 CLASS II
HR65052	Max.7W	Gu10 bulbs	220-240V~50Hz	IP65 CLASS II



### Technology Data

- ⚙️ **Item No.: HR65031/HR65032/HR65033**
- ⚙️ AC220/240V,50/60Hz
- ⚙️ LED 8W ± 10%,480lm ± 10%
- ⚙️ Body in ABS+PC.
- ⚙️ Diffuser in Frosted PC.

**CLASS II IP 54**

### Technology Data-Operating mode



**Push button switch control**



- ☀️ - Hold the switch for 3S to control the microwave sensor function -- on or off

### Adjustable Color

**3000K 4000K 6000K**

- ☀️ - Push the Switch to fix the color  
3000K -6000K-4000K-off
- Microwave induction function is on:  
3000K light30%-light100%(motion sensor)  
6000K light30%-light100%(motion sensor)  
4000K light30%-light100%(motion sensor)



HR65031



HR65032



HR65033-500  
HR65033-800

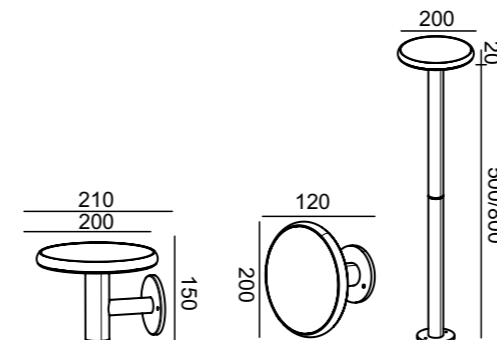



**Technology Data**

- ⊗ E27 bulbs Max.28W
- ⊗ Body in ABS+PC.
- ⊗ Diffuser in Opaline PC.



HR65021



HR65022-600  
HR65022-800

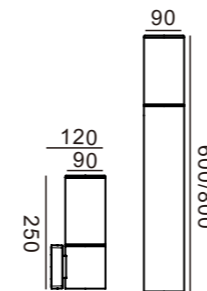

Item.No.	Watts	Light Source	Input	Safety type
HR65021	Max.28W	E27 bulbs	220-240V~50Hz	IP54 CLASS II
HR65022-600	Max.28W	E27 bulbs	220-240V~50Hz	IP54 CLASS II
HR65022-800	Max.28W	E27 bulbs	220-240V~50Hz	IP54 CLASS II





**Technology Data**

- ⊗ GU10 bulbs Max.7W
- ⊗ Body in ABS+PC.
- ⊗ Diffuser in Clear PC.



HR60203



HR60205



HR60204



HR60206

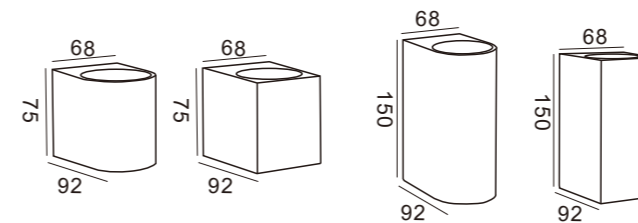

Item.No.	Watts	Light Source	Input	Safety type
HR60203	Max.7W	Gu10 bulbs	220-240V~50Hz	IP44/65 CLASS II
HR60204	Max.7W	Gu10 bulbs	220-240V~50Hz	IP44/65 CLASS II
HR60205	Max.7W	Gu10 bulbs	220-240V~50Hz	IP44/65 CLASS II
HR60206	Max.7W	Gu10 bulbs	220-240V~50Hz	IP44/65 CLASS II



**Technology Data**

- ⊗ GU10 bulbs Max.7W
- ⊗ Body in PP.
- ⊗ Diffuser in Clear PC.



HR60255



HR60256



HR60257



PIR motion  
Sensor



HR60258



PIR motion  
Sensor

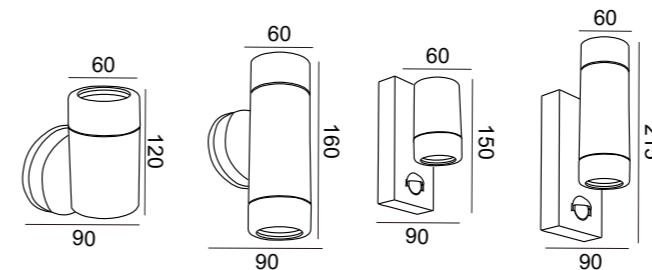

Item.No.	Watts	Light Source	Input	Safety type
HR60255	Max.7W	Gu10 bulbs	220-240V~50Hz	IP54 CLASS II
HR60256	Max.7W	Gu10 bulbs	220-240V~50Hz	IP54 CLASS II
HR60257	Max.7W	Gu10 bulbs	220-240V~50Hz	IP44 CLASS II
HR60258	Max.7W	Gu10 bulbs	220-240V~50Hz	IP44 CLASS II

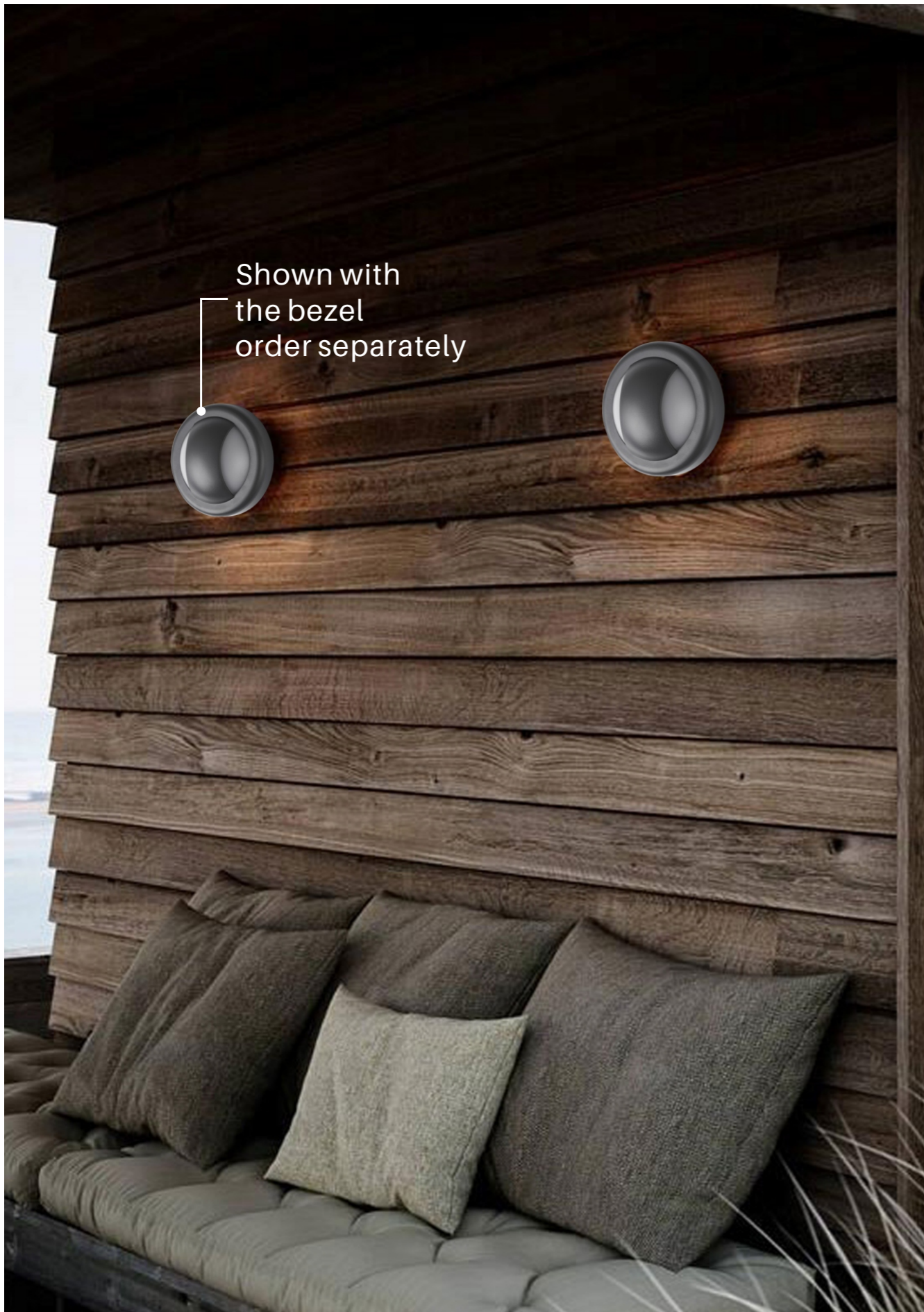

### Technology Data

- ⊗ LED Lamp
- ⊗ Body in ABS+PC.
- ⊗ Diffuser in Opaline PC.

3000K-4000K-6000K



select CCT  
via Dip Switch



HR20004



HR20003



HR20005



HR20002

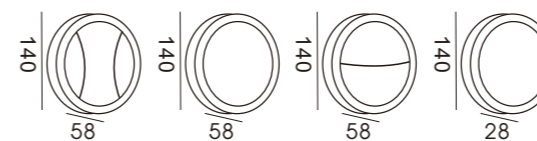

#### Available Accessories:

- A: round bezel accessory
- B: eyelid bezel accessory
- C: up/down bezel accessory
- D: down bezel accessory

Item.No.	Watts	3000K	4000K	6000K	CRI	Input	Safety type
HR20004	6W	197lm	220lm	210lm	80	220-240V~50Hz	IP65 CLASS II
HR20003	6W	450lm	500lm	485lm	80	220-240V~50Hz	IP65 CLASS II
HR20005	6W	280lm	240lm	280lm	80	220-240V~50Hz	IP65 CLASS II
HR20002	6W	480lm	530lm	500lm	80	220-240V~50Hz	IP65 CLASS II



**Technology Data**

- ⊗ LED Lamp
- ⊗ Body in ABS+PC.
- ⊗ Diffuser in Opaline PC.

3000K-4000K-6000K



select CCT  
via Dip Switch



HR20014



HR20015



HR20013



HR20012

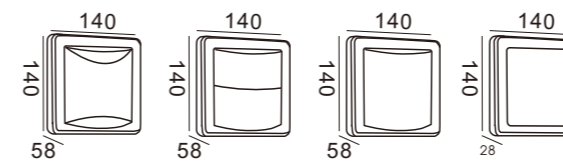

**Available Accessories:**

- A: square bezel accessory
- B: eyelid bezel accessory
- C: up/down bezel accessory
- D: down bezel accessory

Item.No.	Watts	3000K	4000K	6000K	CRI	Input	Safety type
HR20014	6W	97lm	100lm	95lm	80	220-240V~50Hz	IP65 CLASS II
HR20013	6W	242lm	246lm	235lm	80	220-240V~50Hz	IP65 CLASS II
HR20015	6W	545lm	584lm	573lm	80	220-240V~50Hz	IP65 CLASS II
HR20012	6W	550lm	570lm	560lm	80	220-240V~50Hz	IP65 CLASS II



Shown with  
the bezel  
order separately

**Technology Data**

- ⊗ LED Lamp
- ⊗ Body in ABS+PC.
- ⊗ Diffuser in Opaline PC.

3000K-4000K-6000K



select CCT  
via Dip Switch



HR20025



HR20023



HR20024



HR20022

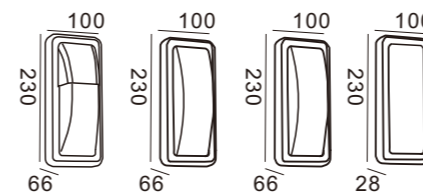

**Available Accessories:**

- A: square bezel accessory
- B: eyelid bezel accessory
- C: up/down bezel accessory
- D: down bezel accessory

Item.No.	Watts	3000K	4000K	6000K	CRI	Input	Safety type
HR20024	6W	334lm	372lm	354lm	80	220-240V~50Hz	IP65 CLASS II
HR20023	6W	505lm	556lm	550lm	80	220-240V~50Hz	IP65 CLASS II
HR20025	6W	240lm	280lm	260lm	80	220-240V~50Hz	IP65 CLASS II
HR20022	6W	533lm	584lm	553lm	80	220-240V~50Hz	IP65 CLASS II

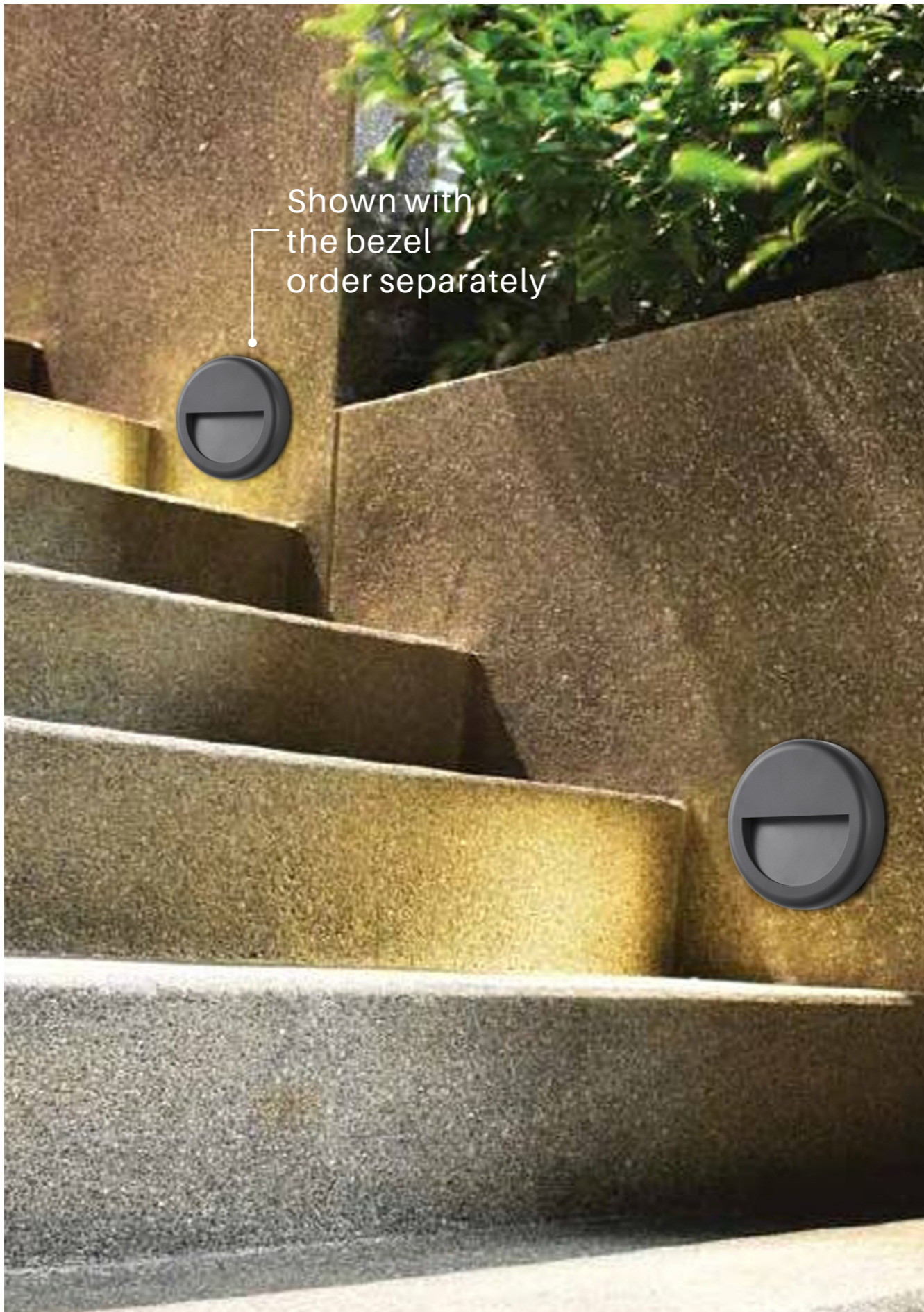

Shown with  
the bezel  
order separately

**Technology Data**

- ⊗ LED Lamp
- ⊗ Body in ABS+PC.
- ⊗ Diffuser in Clear PC.

3000K-4000K-6000K



select CCT  
via Dip Switch



HR20001



HR20011



HR20021

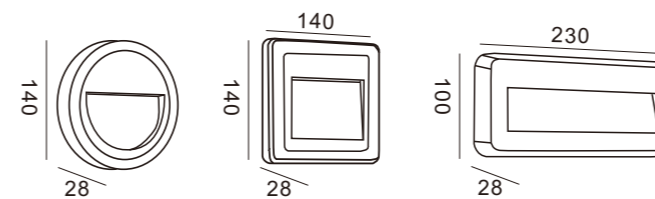

Item.No.	Watts	3000K	4000K	6000K	CRI	Input	Safety type
HR20001	4W	96lm	100lm	95lm	80	220-240V~50Hz	IP65 CLASS II
HR20011	4W	96lm	100lm	96lm	80	220-240V~50Hz	IP65 CLASS II
HR20021	4W	95lm	100lm	96lm	80	220-240V~50Hz	IP65 CLASS II

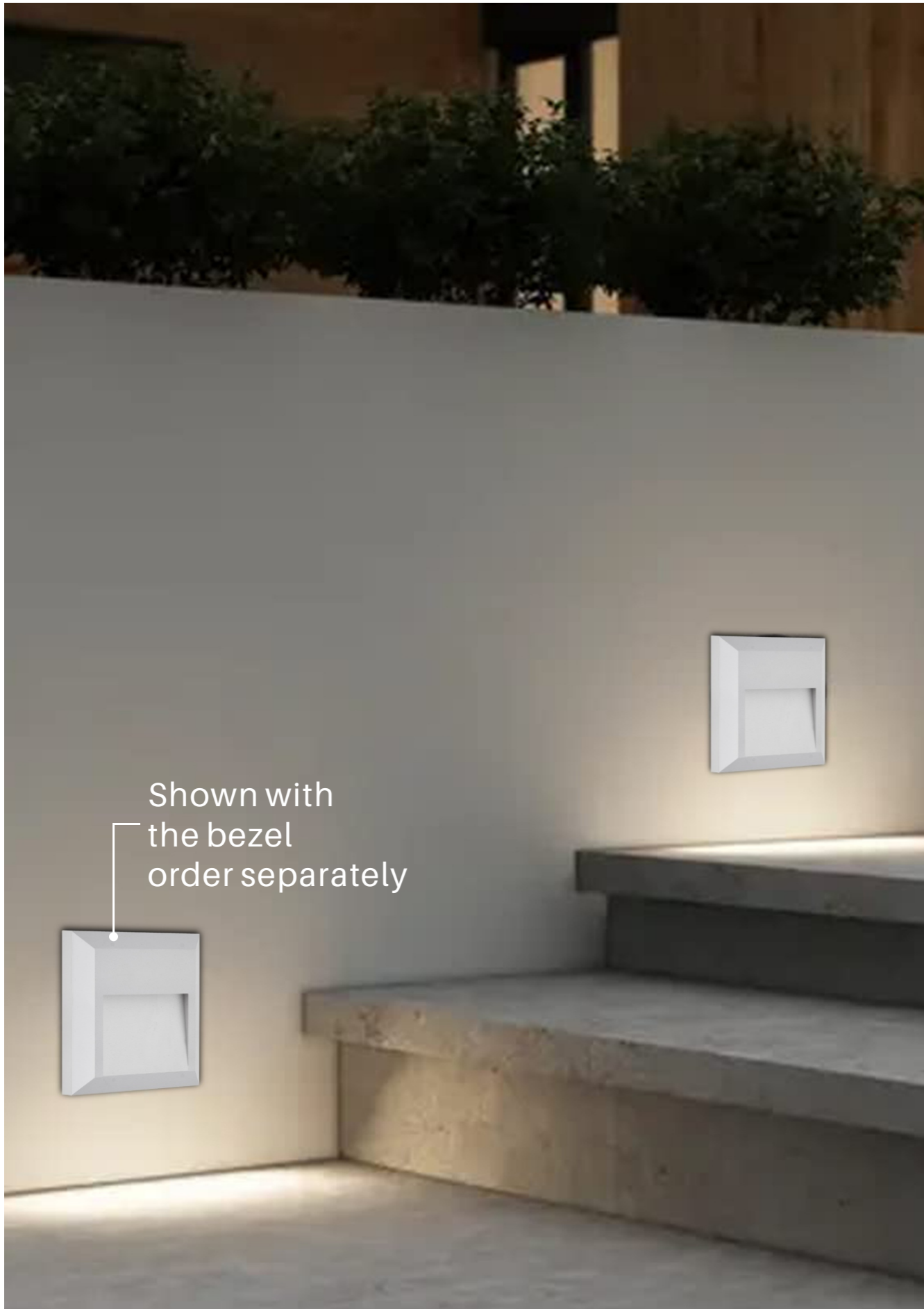

**Technology Data**

- ⊗ LED Lamp
- ⊗ Body in ABS+PC.
- ⊗ Diffuser in Opaline PC.

3000K-4000K-6000K



select CCT  
via Dip Switch

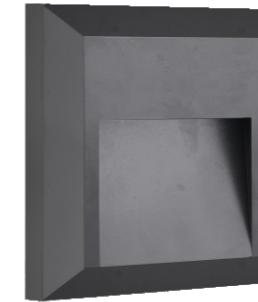

HR20031



HR20032



HR20041



HR20042

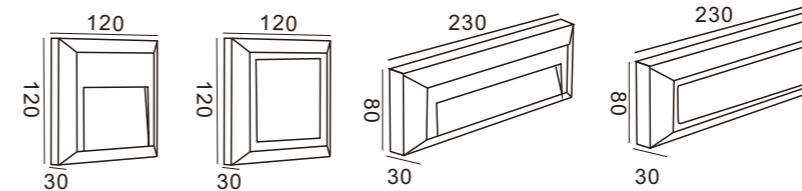

Item.No.	Watts	3000K	4000K	6000K	CRI	Input	Safety type
HR20031	4W	145lm	170lm	168lm	80	220-240V~50Hz	IP65 CLASS II
HR20032	4W	350lm	360lm	360lm	80	220-240V~50Hz	IP65 CLASS II
HR20041	4W	125lm	155lm	165lm	80	220-240V~50Hz	IP65 CLASS II
HR20042	4W	265lm	285lm	290lm	80	220-240V~50Hz	IP65 CLASS II



**Technology Data**

- ⊗ LED Lamp
- ⊗ Body in ABS+PC.
- ⊗ Diffuser in Opaline PC.

3000K-4000K-6000K



select CCT  
via Dip Switch



HR65041



HR65043



HR65042

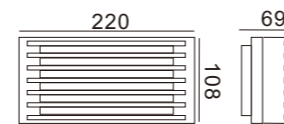

Item.No.	Watts	3000K	4000K	6000K	CRI	Input	Safety type
HR65041	10W	650lm	660lm	640lm	80	220-240V~50Hz	IP54 CLASS I
HR65042	10W	570lm	580lm	570lm	80	220-240V~50Hz	IP54 CLASS I
HR65043	10W	350lm	360lm	340lm	80	220-240V~50Hz	IP54 CLASS I